



call your distributor today:
HULL SUPPLY CO., AUSTIN, TX 512.385.1262 www.hullsupply.com



Toilet Partition Measurement Guide

A Step-By-Step Guide to Measuring Replacement Toilet Partitions

Call your Bobrick distributor: HULL SUPPLY CO., AUSTIN, TX 512.385.1262 www.hullsupply.com

Measurement Guide - Recessed Layout

Before You Begin:

- Sketch building wall locations. Note building walls with double hash marks.
- Mark approximate toilet locations in stall (Note: toilets should be located 18" from either side wall or side divider panel on barrier-free layouts).
- Sketch existing components (stiles, panels, doors). Remember to include door swings (left, right, inswing, outswing).

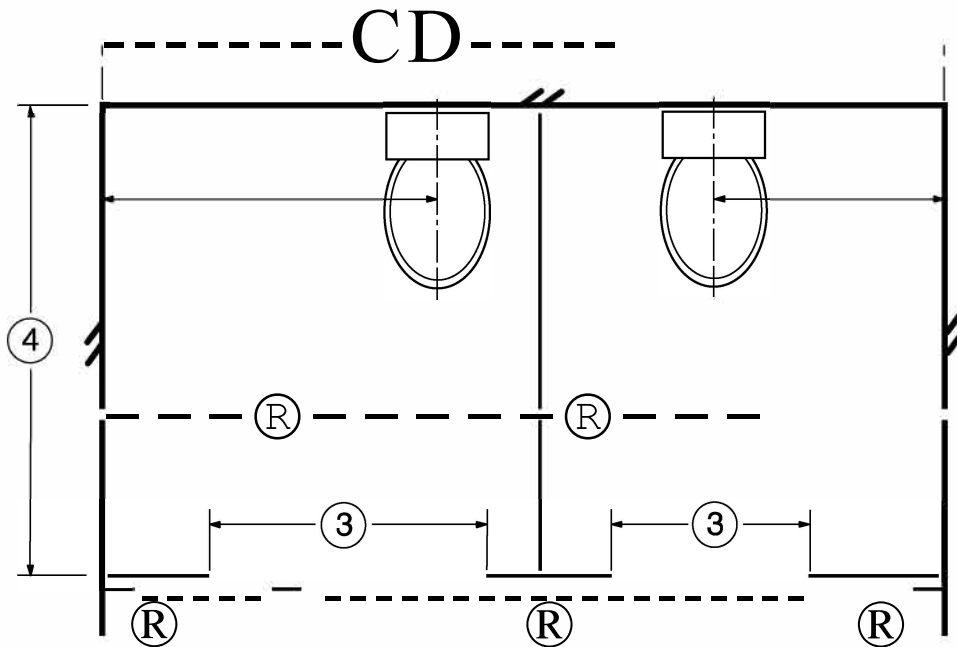

What to Measure:

- Side wall to side wall.
 - Side wall to centerline of divider panel.
 - Door opening (stile edge to stile edge).
 - Compartment depth (back wall to front/outside edge of stile).
 - Existing stile width.
- HRI -- Headrail runs across front width of compartments from wall to wall.

Call your Bobrick distributor: HULL SUPPLY CO., AUSTIN, TX 512.385.1262 www.hullsupply.com



Measurement Guide - Corner Layout

Before You Begin:

- a. Sketch building wall locations. Note building walls with double hash marks.
- b. Mark approximate toilet locations in stall (Note: toilets should be located 18" from either side wall or side divider panel on barrier-free layouts).
- c. Sketch existing components (stiles, panels, doors). Remember to include door swings (left, right, inswing, outswing).

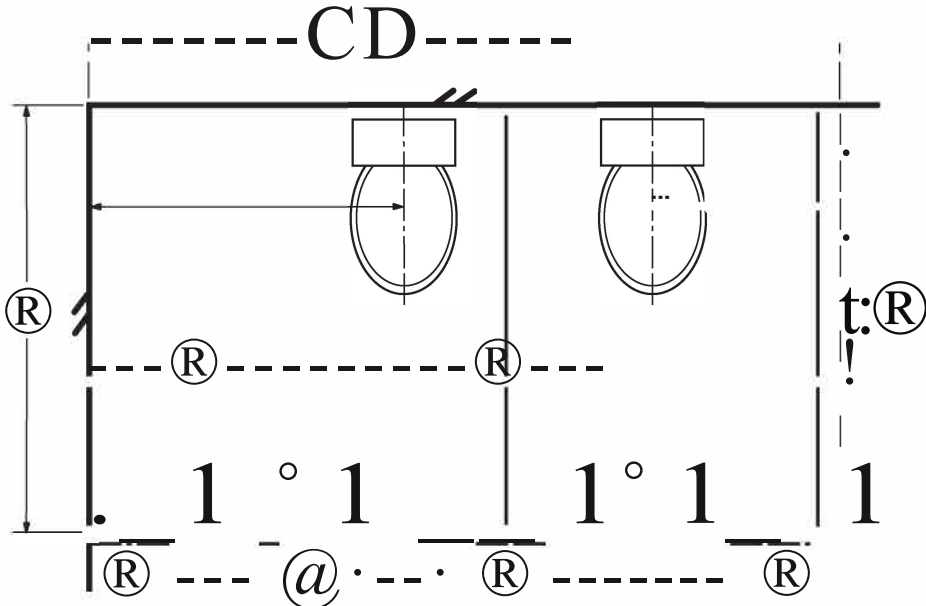

What to Measure:

- 1. Side wall to outside edge of stile.
 - 2. Side wall to centerline of divider panel.
 - 3. Centerline of panel to outside of panel.
 - 4. Door opening (stile edge to stile edge).
 - 5. Compartment depth (back wall to front/outside edge of stile).
 - 6. Existing stile width.
- HR1 -- Headrail runs across front width of compartment to outside edge of corner stile.
 HR2 -- Headrail runs from back side of corner stile to back wall (over top of end panel).

Call your Bobrick distributor: HULL SUPPLY CO., AUSTIN, TX 512.385.1262 www.hullsupply.com



Measurement Guide - Alcove Layout

Before You Begin:

- Sketch building wall locations. Note building walls with double hash marks.
- Mark approximate toilet locations in stall (Note: toilets should be located 18" from either side wall or side divider panel on barrier-free layouts).
- Sketch existing components (stiles, panels, doors). Remember to include door swings (left, right, inswing, outswing).

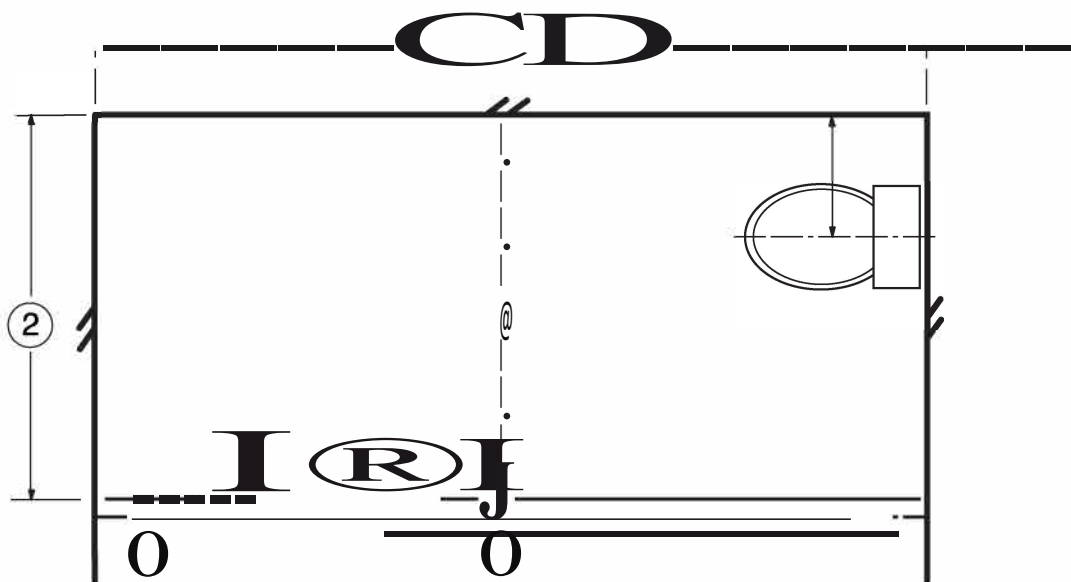

What to Measure:

- Side wall to side wall.
 - Compartment depth (back wall to front/outside edge of stile).
 - Door opening (stile edge to stile edge).
 - Existing stile width.
- HR1 -- Headrail runs across front width of compartments from wall-to-wall.
HR2 -- Headrail runs from stile to back wall.

Call your Bobrick distributor: HULL SUPPLY CO., AUSTIN, TX 512.385.1262 www.hullsupply.com



Toilet Partition Measurement

Bobrick Design Notes:

1. 3", 4" or 5" stile may only be used at wall or attached perpendicular to a side panel.

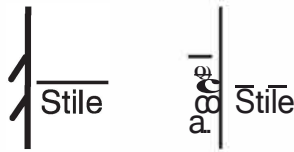

2. Average standard compartment is 30-36" wide, 54-60" deep.
3. Inswing doors average 23-26".
4. Wall-hung screens are 42" high, maximum 24" deep.
5. Door hardware requires 2" mounting offset on stile.

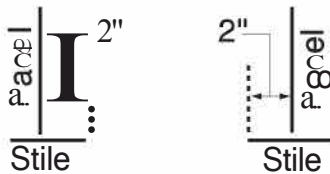

6. Overhead braced or floor-to-ceiling anchored can have flush stile/panel corner.



7. Floor anchored and ceiling hung need minimum 1" stile-to-panel corner offset.



8. Overhead braced or floor-to-ceiling anchored have in-line stile-to-panel connection for alcove. *Stile must be 8". In-line stiles are not recommended for 1080 and 1090 series. On these series a perpendicular stile is recommended. Stile may be as small as 3".

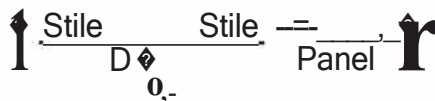

9. Floor anchored and ceiling hung have perpendicular stile-to-panel connection for alcove. *Stile must be 6". For overhead braced stile may be as small as 3".





ADA Design Notes

- 1 Standard barrier-free compartment must be provided in every facility.
 - 60" wide x 60" deep, clear.
 - Centerline of toilet is 18" from one side of compartment.
 - Door opening is opposite corner of toilet.
 - Door opening must be 3' clear, which is 34", 35", 36" or 37" Bobrick door opening.
 - Door opening must be no more than 4" from wall or panel inside edge (this means 3" wide stile or wallpost at wall is only component that complies).

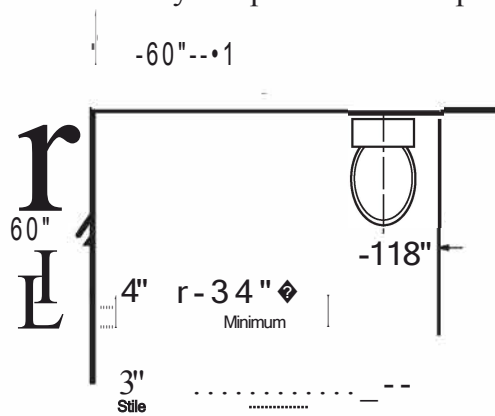

- 2 Alternate compartment must be provided in addition to barrier-free compartment in restrooms with 6 or more compartments.
 - 36" inside clear width (wall-to-panel or panel-to-panel).
 - Conventional depth acceptable but typically 66" depth recommended.
 - Door opening must be 3' clear opening. A 32" clear opening requires at least a 34" door opening.
 - Must use 1-V Z' wall post to hing door off wall.

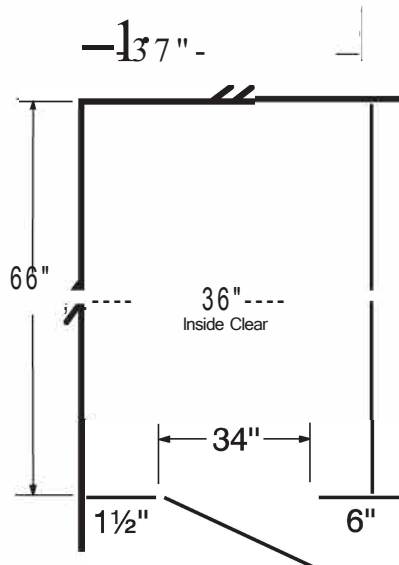



Toilet Partition - Tips, Tricks, and Traps

Site Conditions:

The following site conditions should be checked and noted on your drawing, if applicable.

Minimum Compartment Depth - Inswing Doors

- Standard rule for inswing doors is add 30" (distance from back wall to front of toilet) plus door opening size (stile edge to stile edge). This is the minimum toilet compartment depth required for the door to swing into compartment.
- If compartment is too shallow, need to increase compartment depth or change to outswing door.

Measurement Conventions

- Compartment widths are wall to wall; wall to centerline of panel; centerline of panel to centerline of panel.
- Compartment depths are back wall to outside (front edge) of stile.
- Door is opening size - stile edge to stile edge.

Ceiling Height

- Elevation for overhead-braced toilet compartments is 85" from finished floor to top of headrail - need to ensure ceiling height at least 88" or higher.
- For ceiling-hung or floor-to-ceiling anchored stiles, need to measure ceiling height from finished floor to finished ceiling.
- If floor slopes more than 1" across front of compartments, provide finished floor-to-ceiling measurements at each stile location in layout.

Wall-to-Wall Measurements

- When toilet partitions are recessed between two building walls, the critical measurement is the smallest space between walls.
- Measure wall-to-wall dimensions along the line of the stiles and doors in the toilet compartment (the front).
- Room treatments that will affect measurement will be:
 - *Tile base cove molding*
 - *Wood or other thick baseboard applications*
 - *Wainscoting or decorative trim*
 - *Half-wall tile*
- If there are existing wall treatments, measure smallest distance (i.e. baseboard to baseboard), note on drawings, and request gaps between stile and wall be kept to a minimum (1/2" is minimum gap, 1" is maximum).

Existing Partition Configuration and Materials

- Note existing material, color and condition of partitions.
- Look for Bobrick product which best meets needs of building.
- Try to match existing components and locations where possible - this reduces the amount of "patch and match" required to fill wall bracket and floor anchor holes.

Add-On Sales

- Look for washroom accessory opportunities and other fill-in products.
- Suggest ADA alternatives and ways to become compliant, if possible.

Other Building Conditions that Cause Problems

- Baseboard heaters
- Drains
- Plumbing/pipe runs
- Windows
- Support beams
- Dropped ceilings

Cutouts

- Cutouts may be made in any panel for Bobrick partition-mounted accessories if requested when placing the order. Each panel location should be marked with specific washroom accessory model number.

Left Corner Layouts

1. Fill in door swings.
2. Mark approximate toilet locations.
3. Fill in dimensions and stile size.

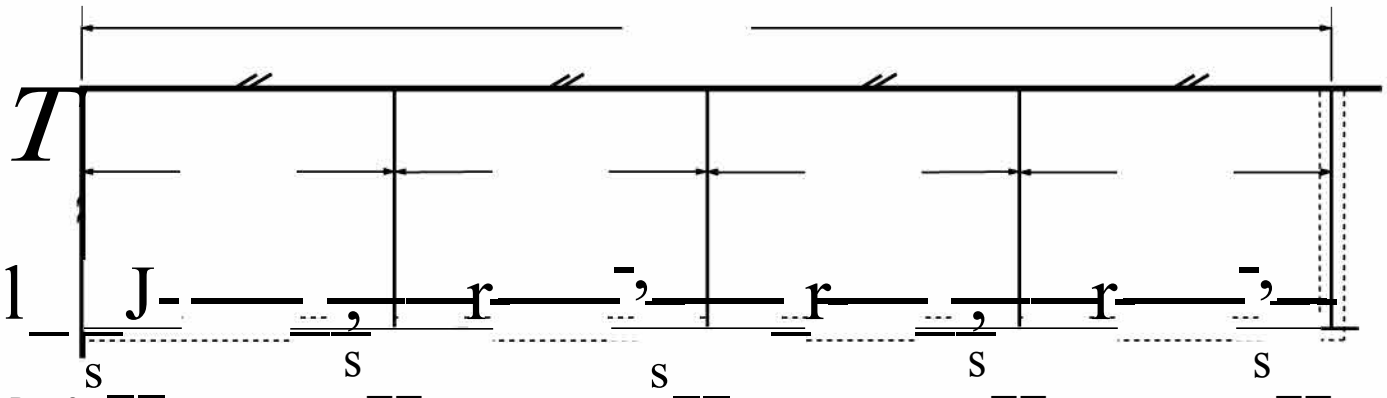
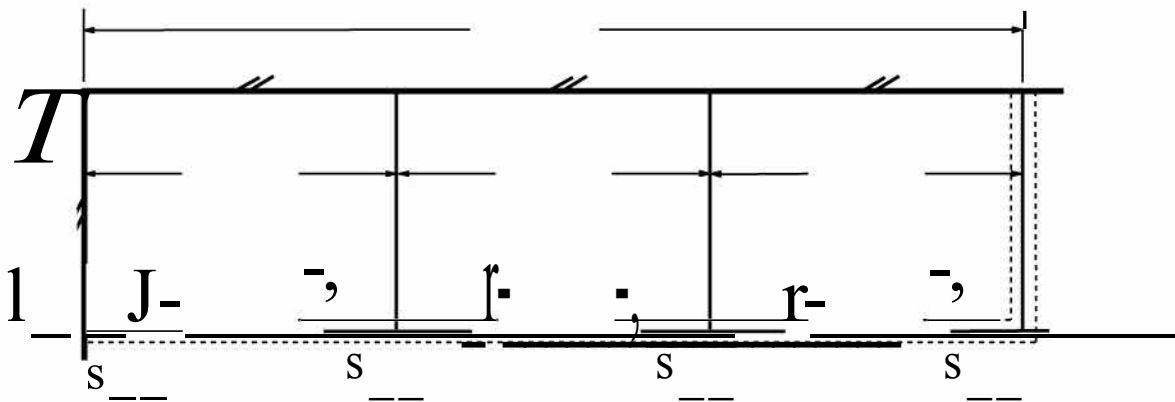
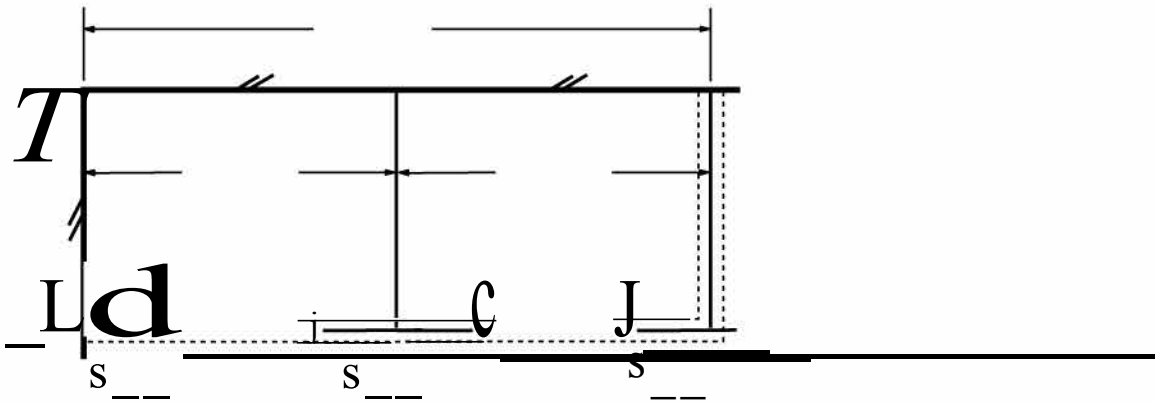
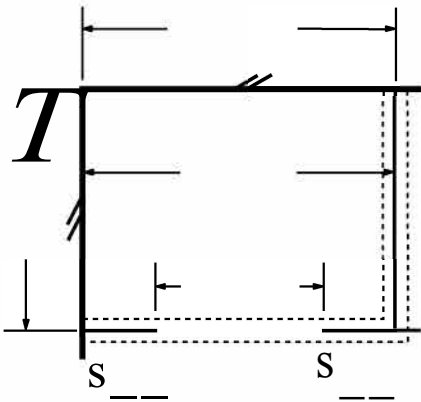



Right Corner Layouts

- 1. Fill in door swings.
- 2. Mark approximate toilet locations.
- 3. Fill in dimensions and stile size.

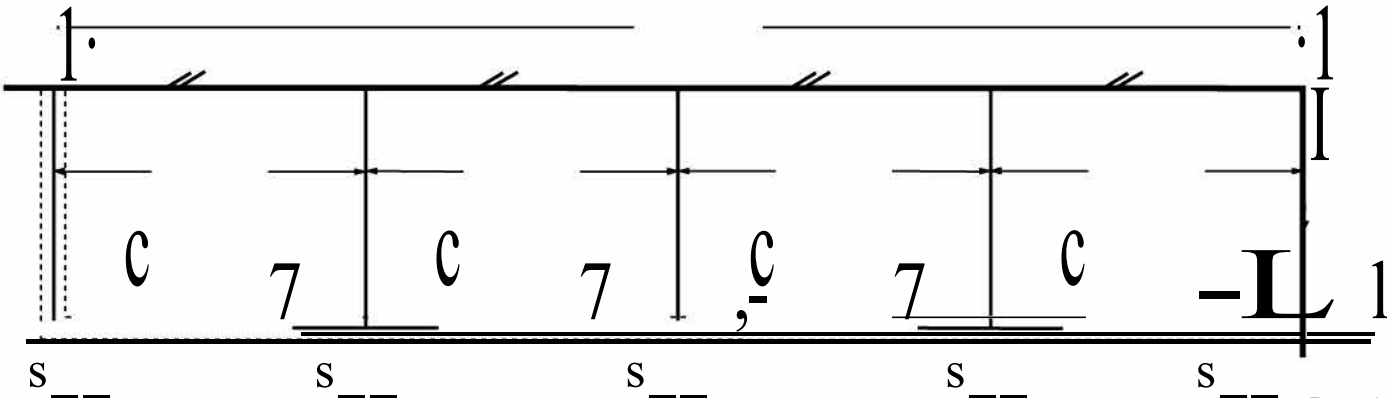
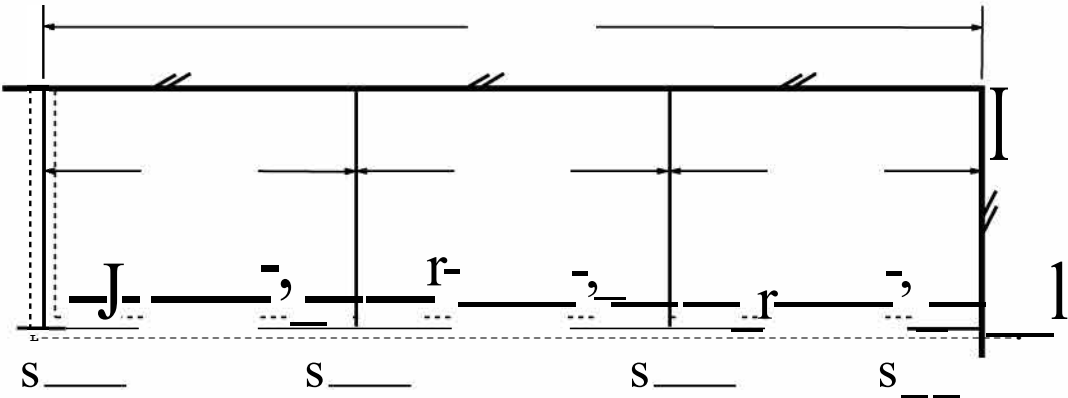
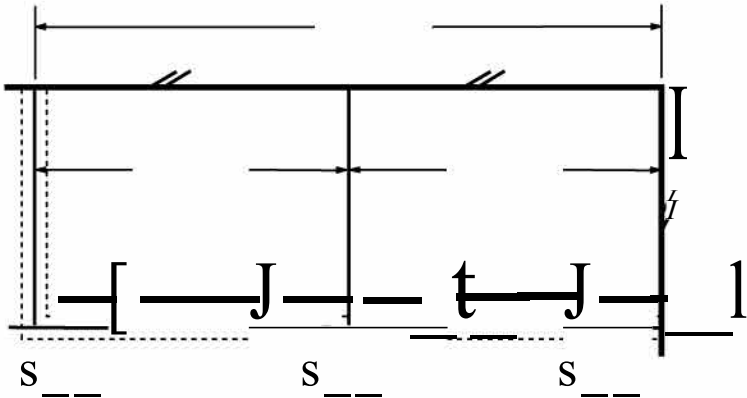
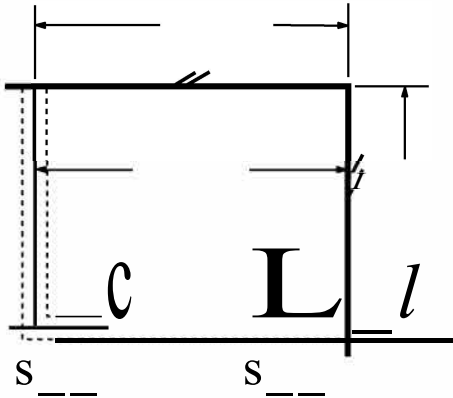

Recessed Layouts

1. Fill in door swings.
2. Mark approximate toilet locations.
3. Fill in dimensions and stile size.

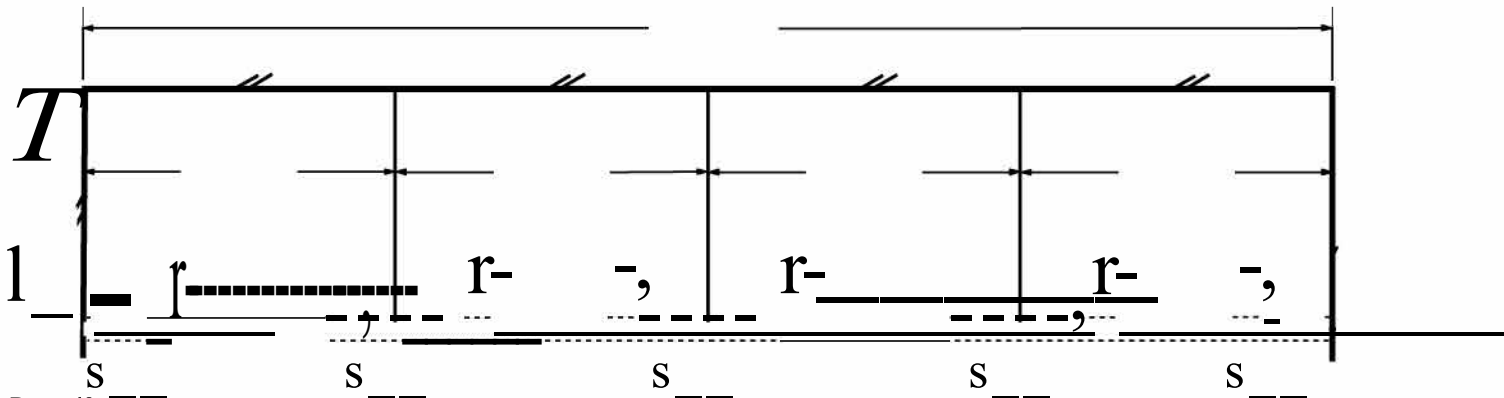
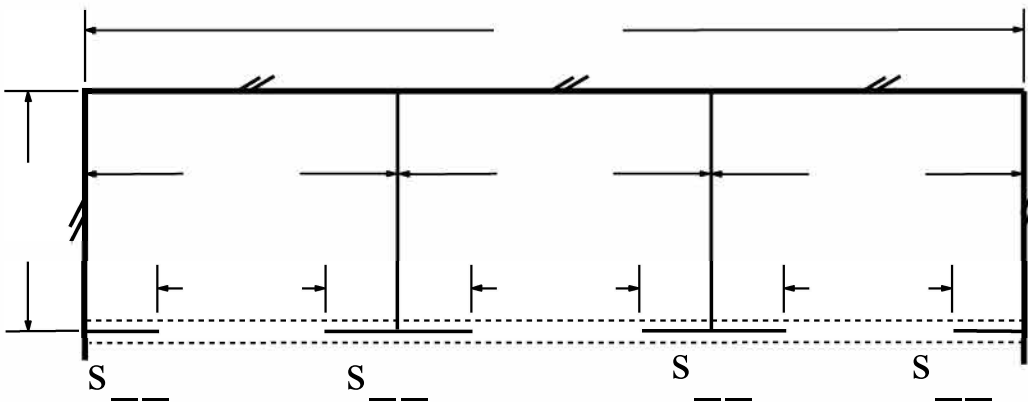
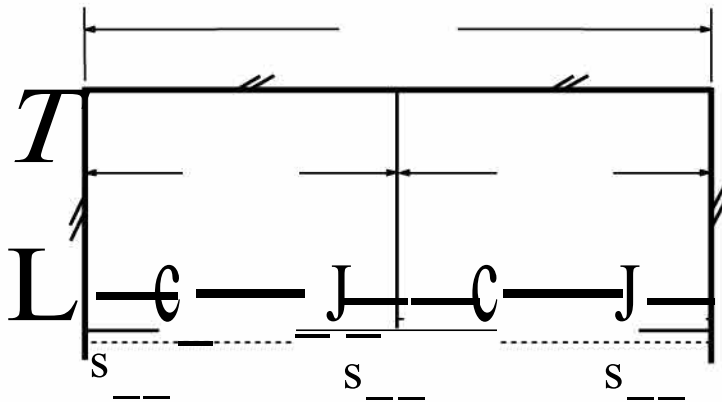
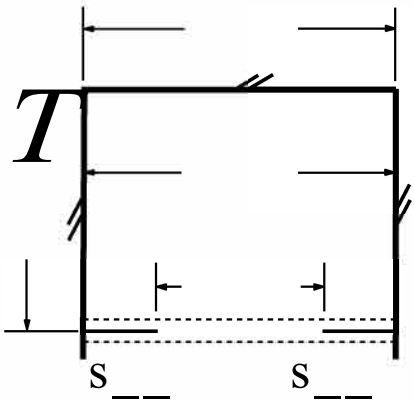

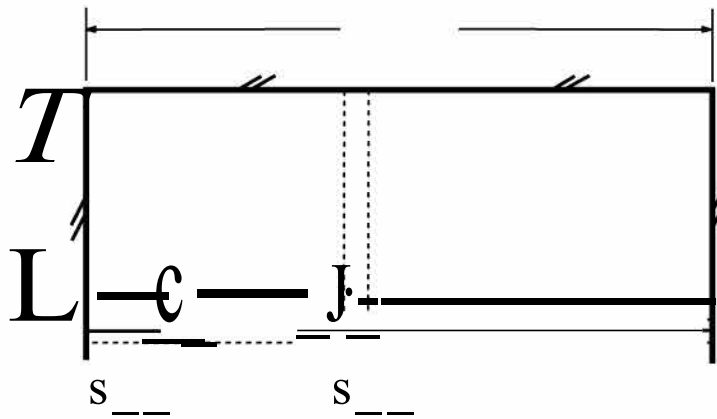

Alcove Layouts

1. Fill in door swings.
2. Mark approximate toilet locations.
3. Fill in dimensions and stile size.

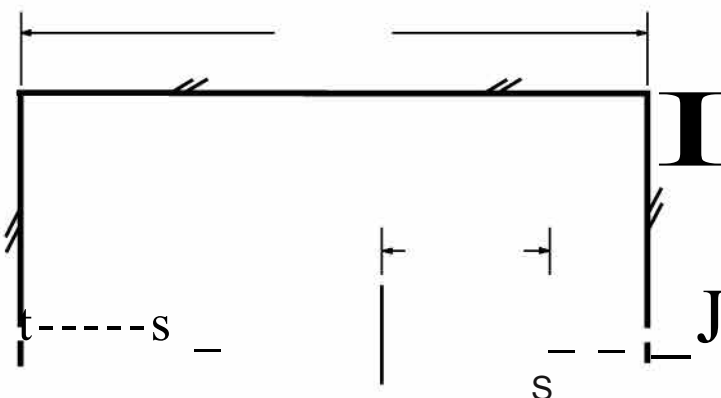
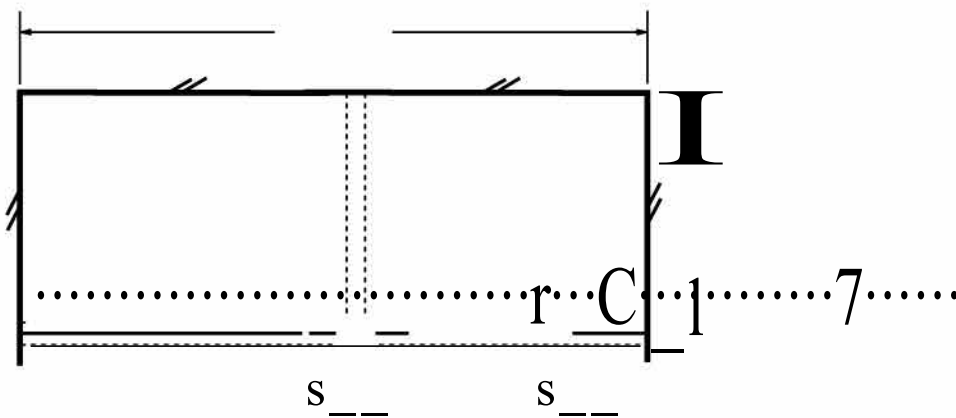
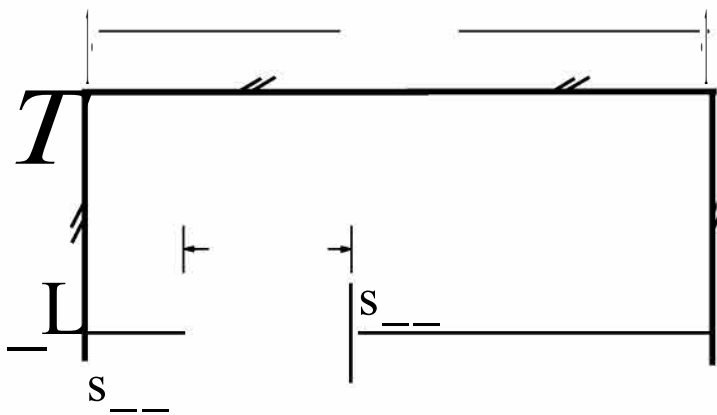

Multiple Layouts©

1. Fill in door swings.
2. Mark approximate toilet locations.
3. Fill in dimensions and stile size.

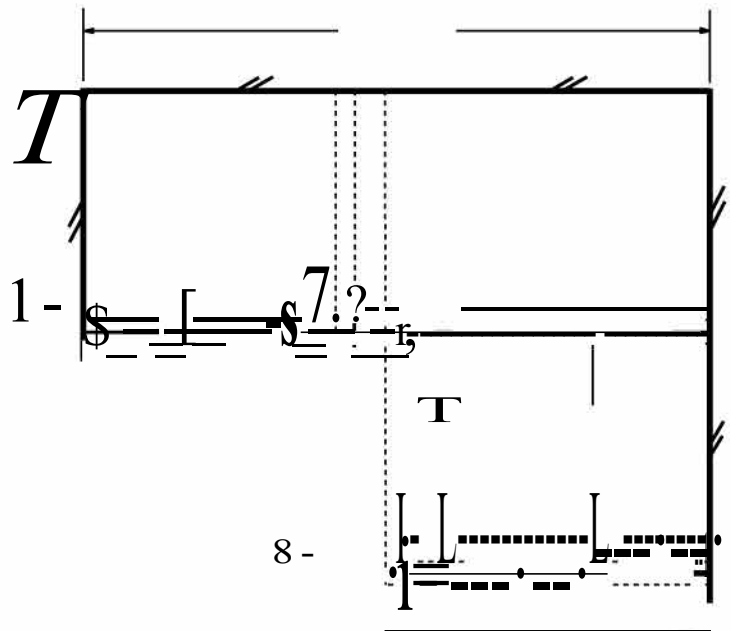

Panel or Wall (Circle One)

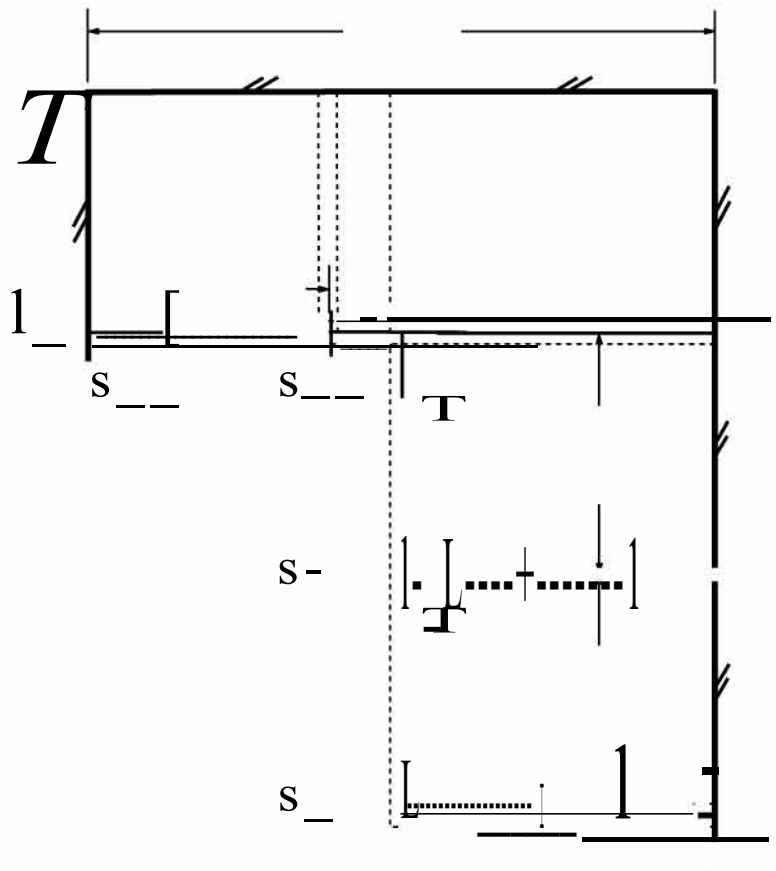

Panel or Wall (Circle One)



Multiple Layout®

- 1. Fill in door swings.
- 2. Mark approximate toilet locations.
- 3. Fill in dimensions and stile size.

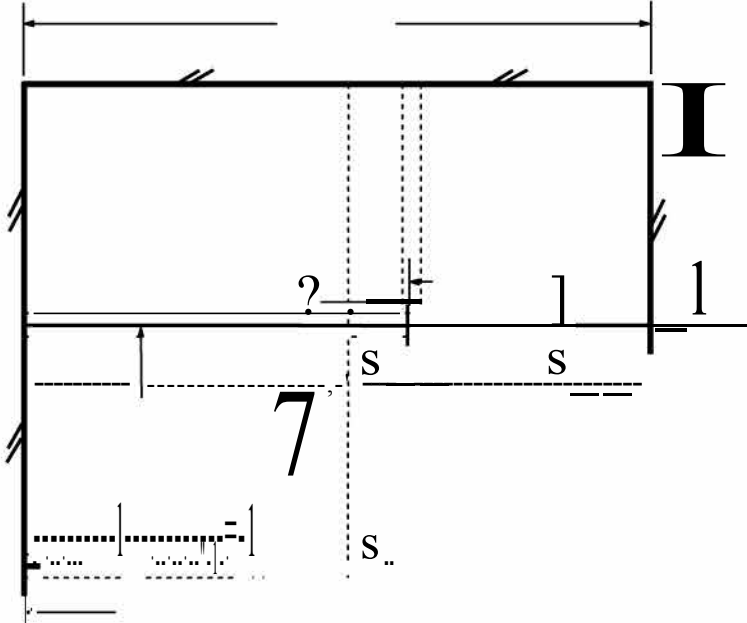

Panel or Wall (Circle One)

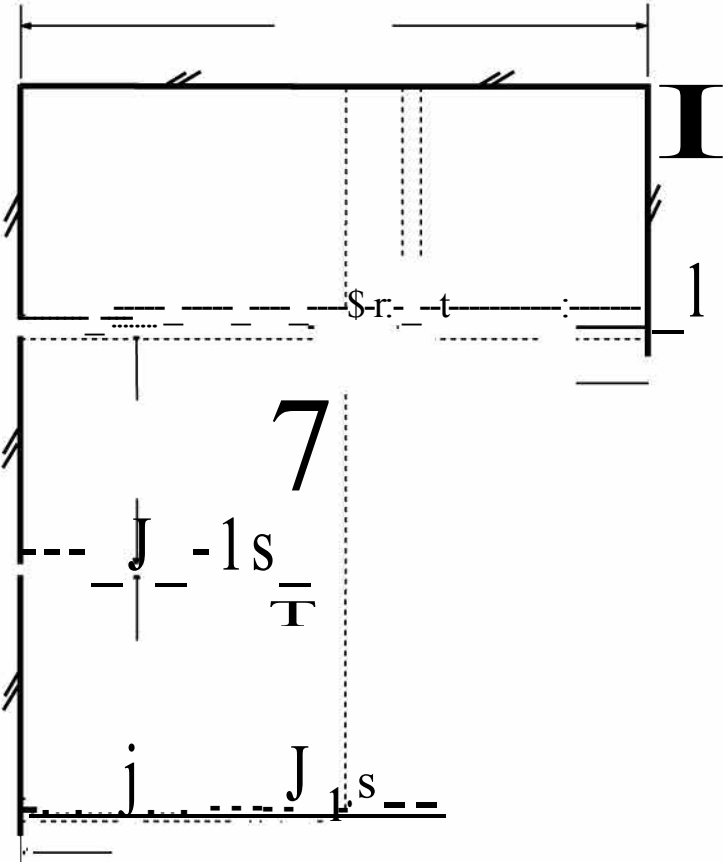

Panel or Wall (Circle One)



Multiple Layouts®

1. Fill in door swings.
2. Mark approximate toilet locations.
3. Fill in dimensions and stile size.

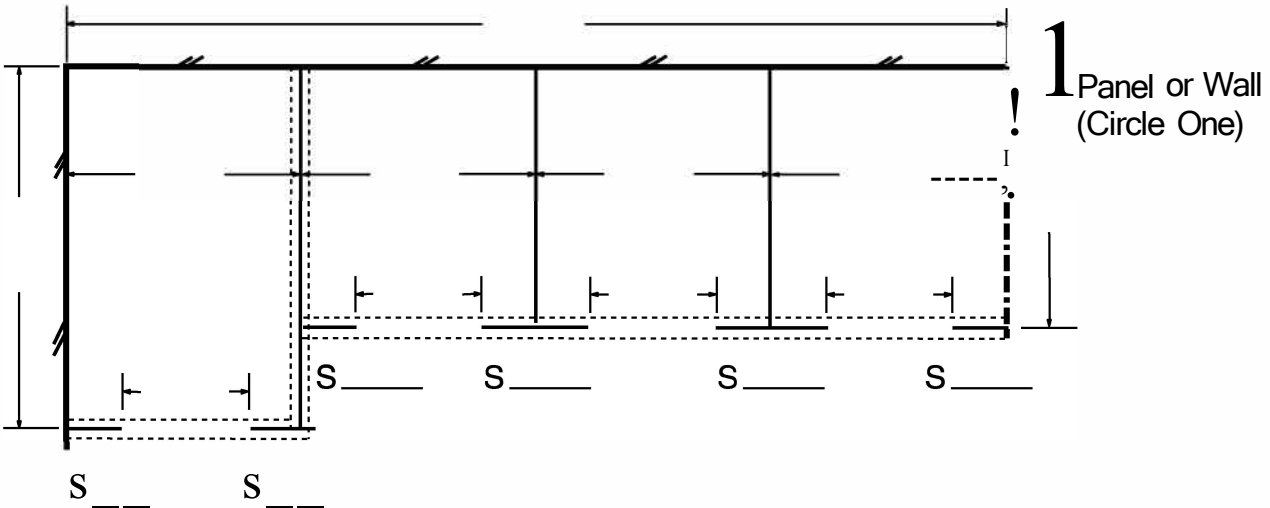
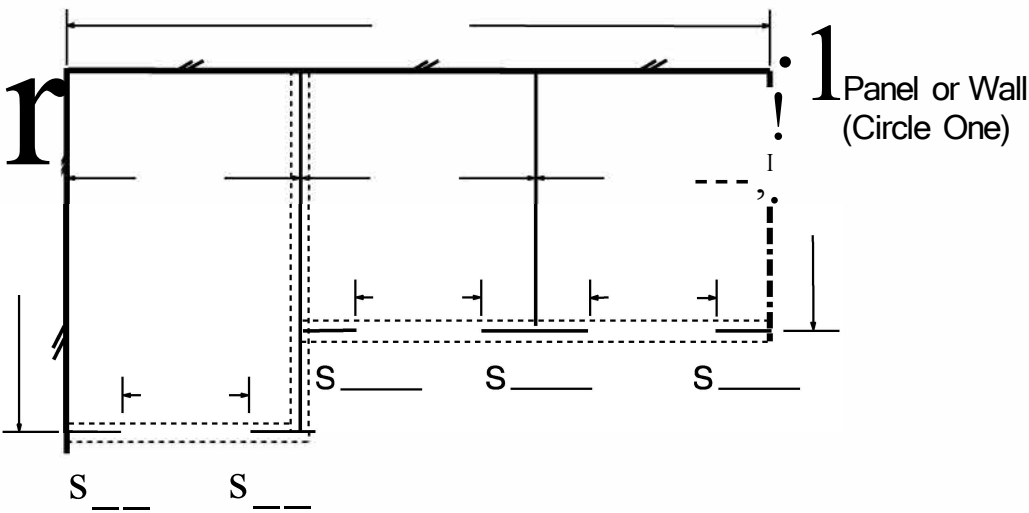
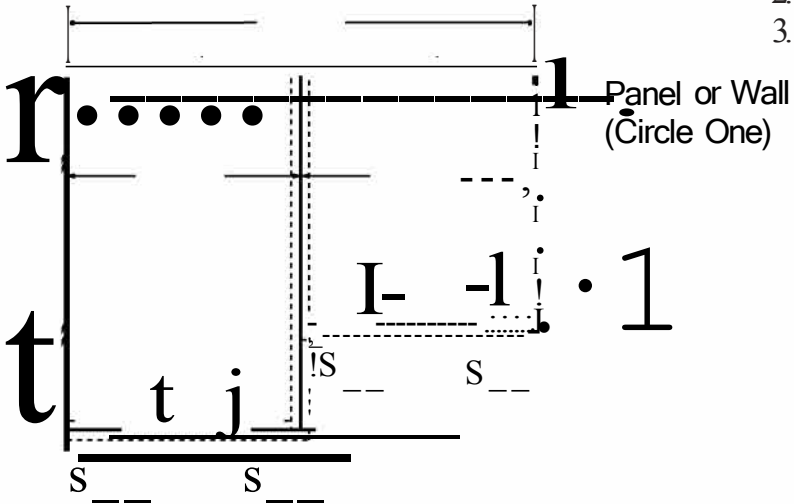



Multiple Layouts@

- 1. Fill in door swings.
- 2. Mark approximate toilet locations.
- 3. Fill in dimensions and stile size.

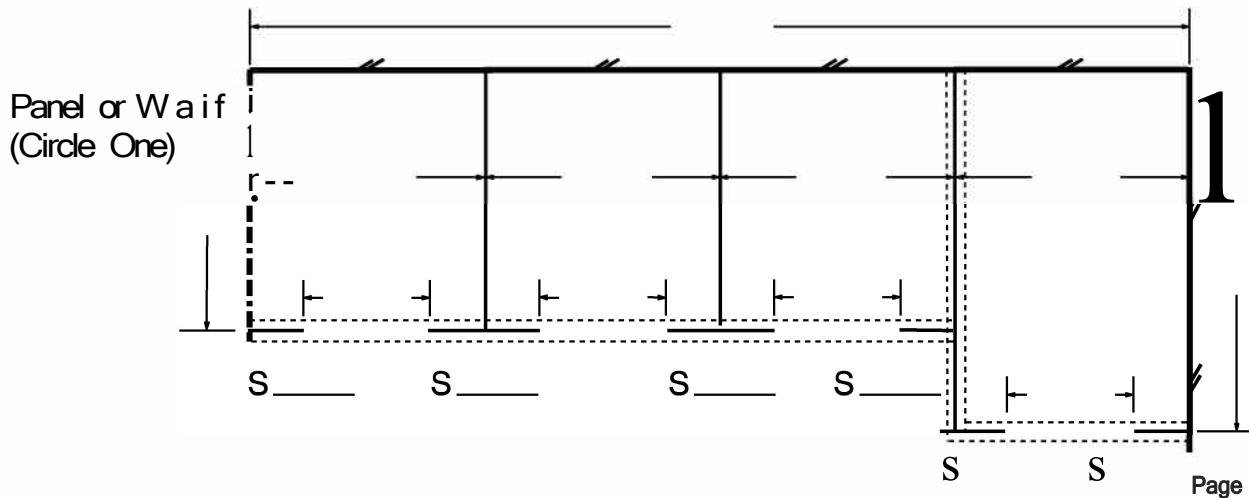
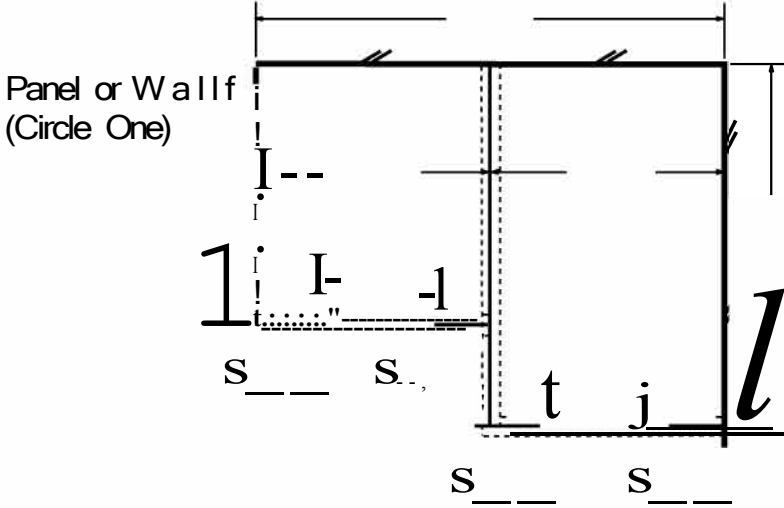



Air Delights, Inc.

11170 SW 5th Street, Beaverton, OR. 97005
Telephone: 800-440-5556, Fax: 503-643-8224

or email Info@AirDelights.com

www.AirDelights.com

Call your Bobrick distributor: HULL SUPPLY CO., AUSTIN, TX 512.385.1262 www.hullsupply.com